

# ◆ I/O 위치 및 회로 구성

▶ [CN16] KEYPAD

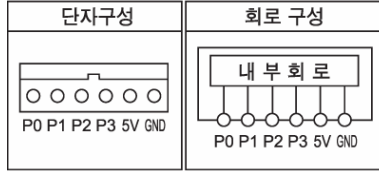

▶ [CN9] 5V OUT



▶ [CN4] PWM OUT

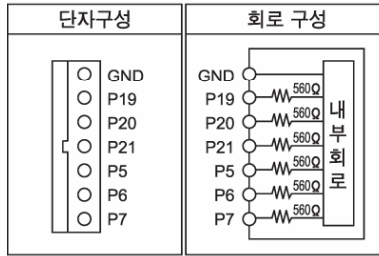

▶ [CN2]

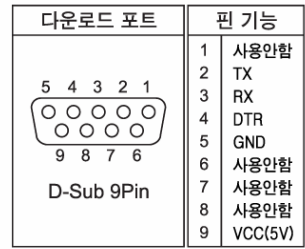

▶ [CN1]

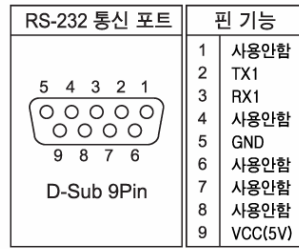

▶ [SW2] AD 입력전압



▶ [CN19] High Count

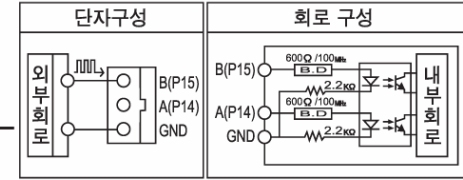

▶ [CN15] AD INPUT

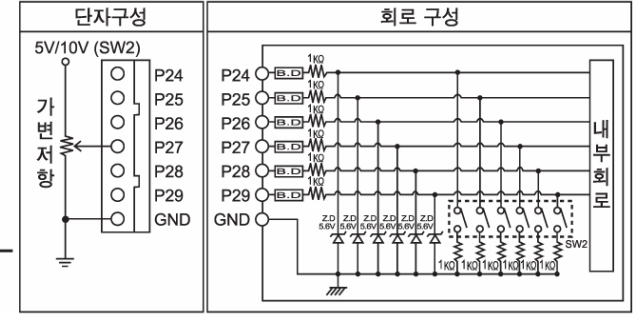

▶ [CN12] CuNET

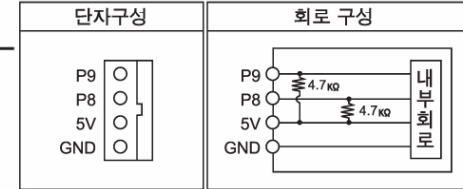

▶ OUTPUT

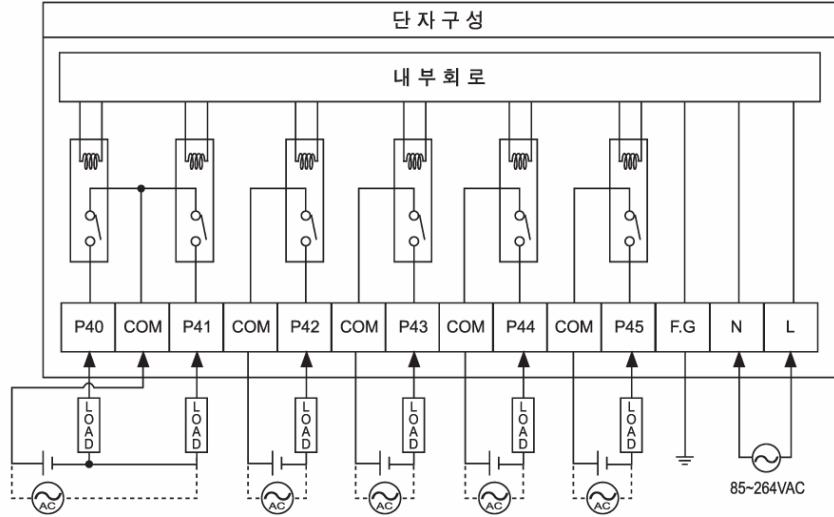

▶ INPUT

